

## Abbinamento dispositivi modulari e placche

Placche		Dispositivi modulari						
		Comandi tradizionali	Pulsanti elettronici	Comandi touch	Prese / altri frutti	Moduli comando touch		
						Tradizionali	KNX	KNX con simboli intercambiabili
ONE		✓	✓	✓	✓	-	-	-
GEO		✓	✓	✓	✓	-	-	-
LUX		✓	✓	✓	✓	-	-	-
ART		✓	✓	✓	✓	-	-	-
ICE	ICE	✓	✓	✓	✓	-	-	-
	ICE Touch (1, 2 o 3 simboli serigrafati)	-	-	-	-	✓	-	-
	ICE Touch KNX (2, 4 o 6 simboli serigrafati)	-	-	-	-	-	✓	-
	ICE Touch KNX	-	-	-	-	-	-	✓

## Tablee dimensionali

### SUPPORTI

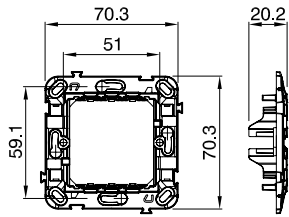

2 POSTI  
GW 16 821 - GW 16 822

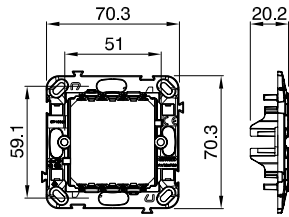

2 POSTI  
GW 16 823

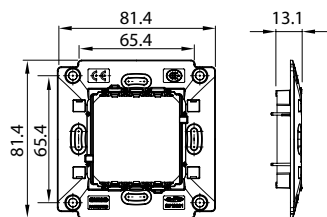

2 POSTI  
GW 16 831

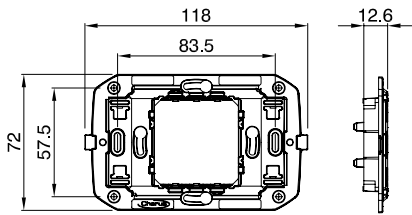

2 POSTI  
GW 16 802

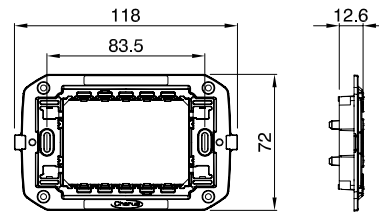

3 POSTI  
GW 16 803

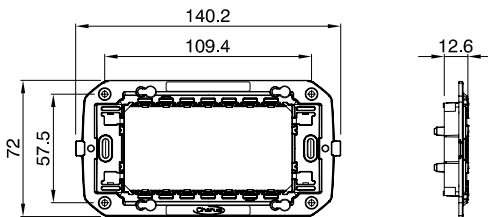

4 POSTI  
GW 16 804

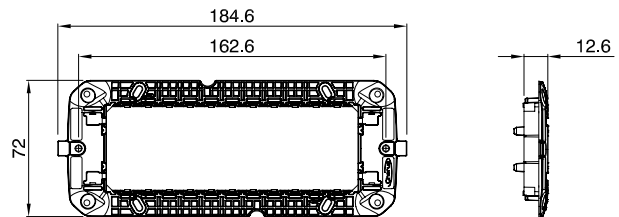

6 POSTI  
GW 16 806

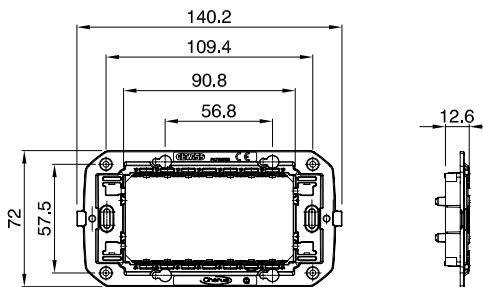

4 POSTI  
GW 16 824  
(Standard francese)

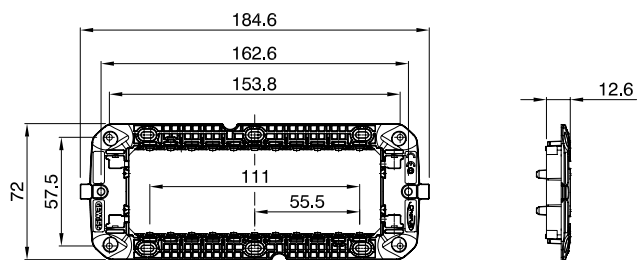

6 POSTI  
GW 16 825  
(Standard francese)

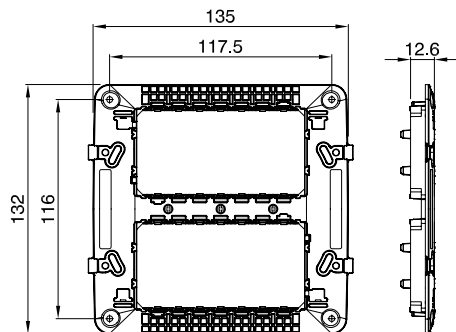

8 (4+4) POSTI  
GW 16 808

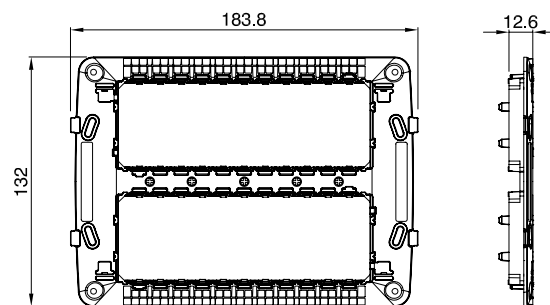

12 (6+6) POSTI  
GW 16 812

## COMPOSIZIONE SUPPORTI PER PLACCHE INTERNAZIONALI

### Composizione orizzontale (interasse 71mm)

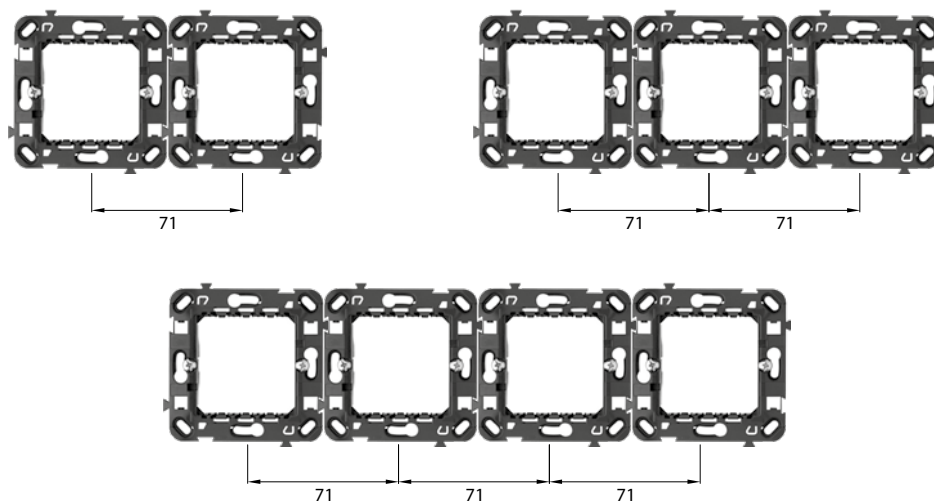

### Composizione verticale (interasse 71mm)

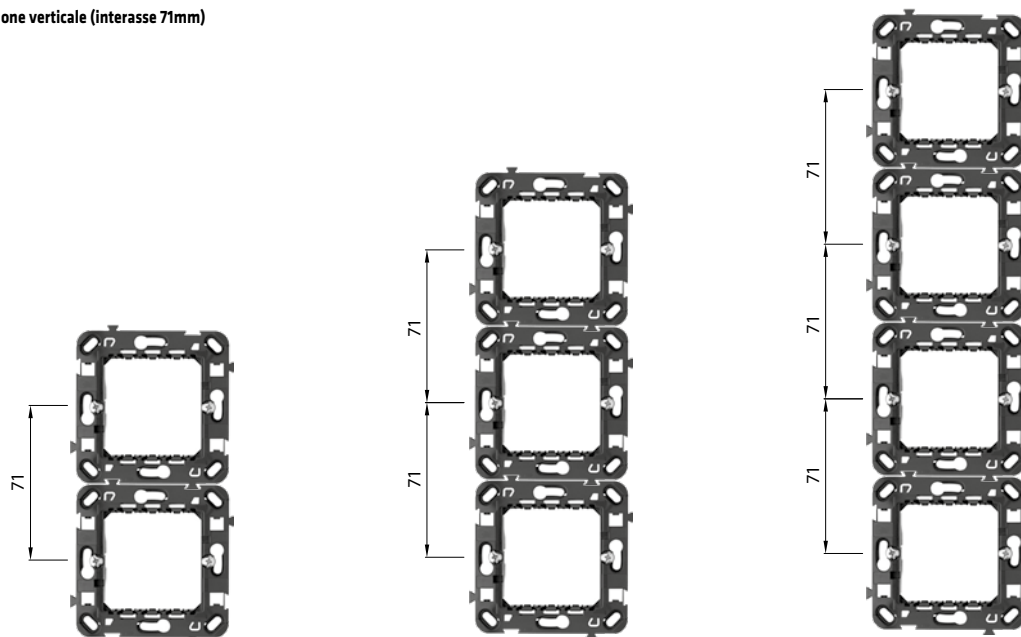

### Composizione verticale (interasse 57mm)

I supporti internazionali GW 16 821, GW 16 822, GW 16 823, grazie ad una pretranciatura, possono essere composti anche con interasse di 57mm.

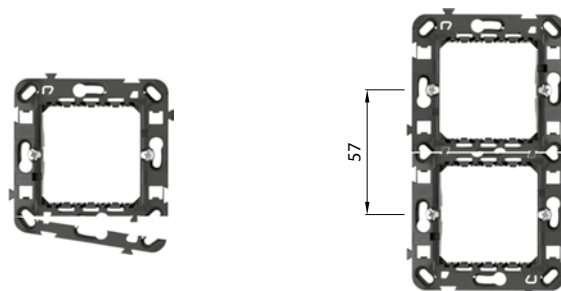

**INTERASSE SCATOLE PER IL CORRETTO FISSAGGIO DELLE PLACCHE CHORUS ONE, GEO, LUX, ART e ICE (DISTANZE MINIME CONSIGLIATE)**

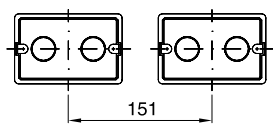

3 POSTI ORIZZONTALE

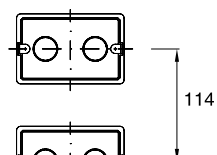

3 POSTI VERTICALE

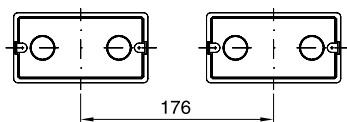

4 POSTI ORIZZONTALE

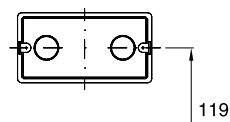

4 POSTI VERTICALE

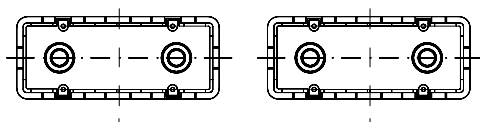

6 POSTI ORIZZONTALE

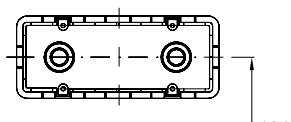

6 POSTI VERTICALE

## PLACCHE ONE

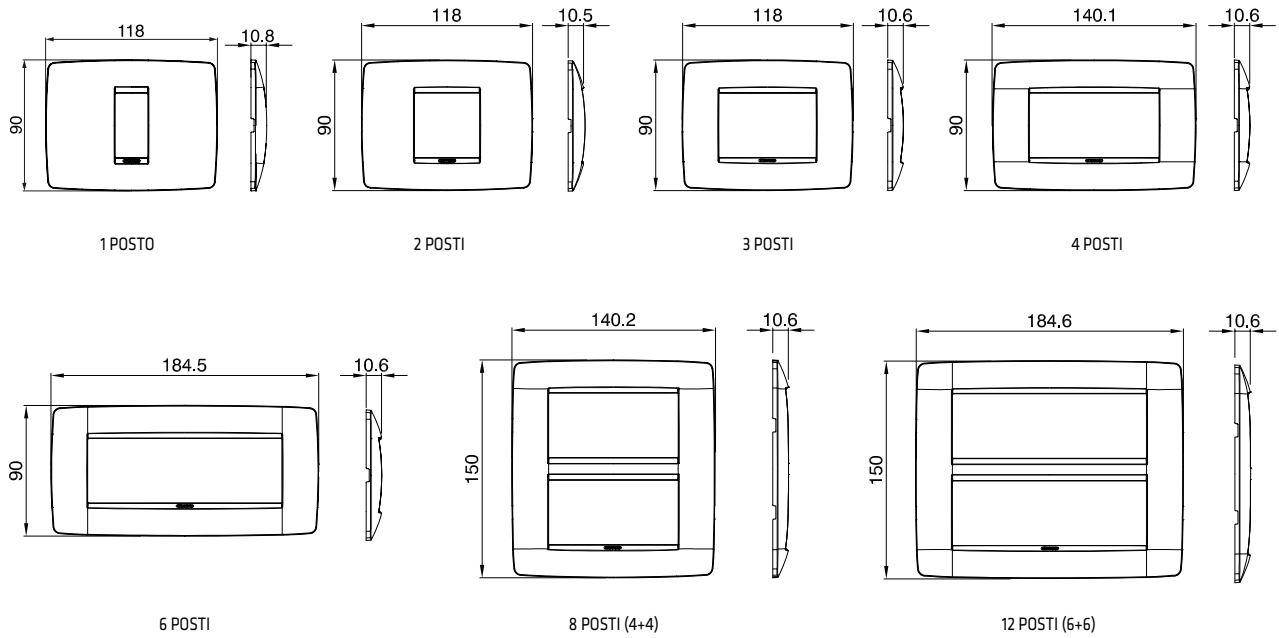

## PLACCHE ONE INTERNATIONAL

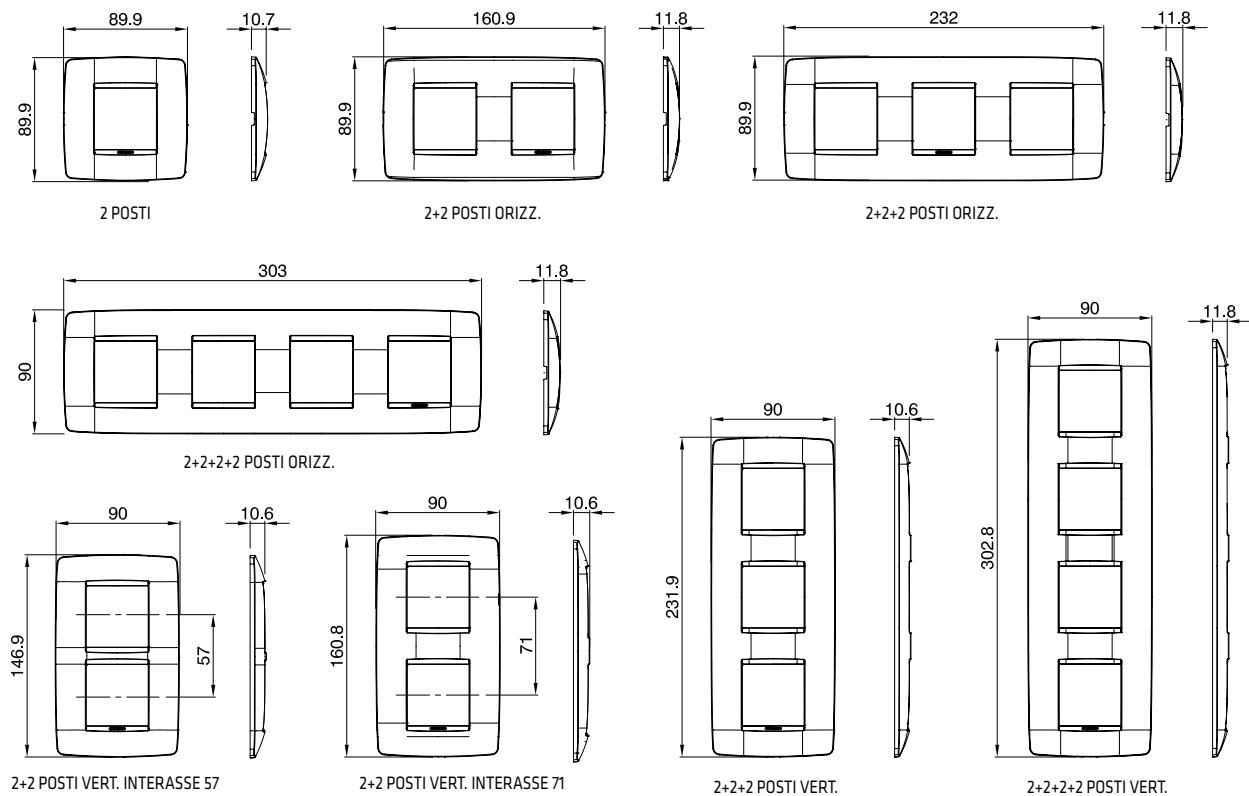

Per informazioni tecniche contattate il SAT o visitate il sito [gewiss.com](http://www.gewiss.com)

## PLACCHE GEO

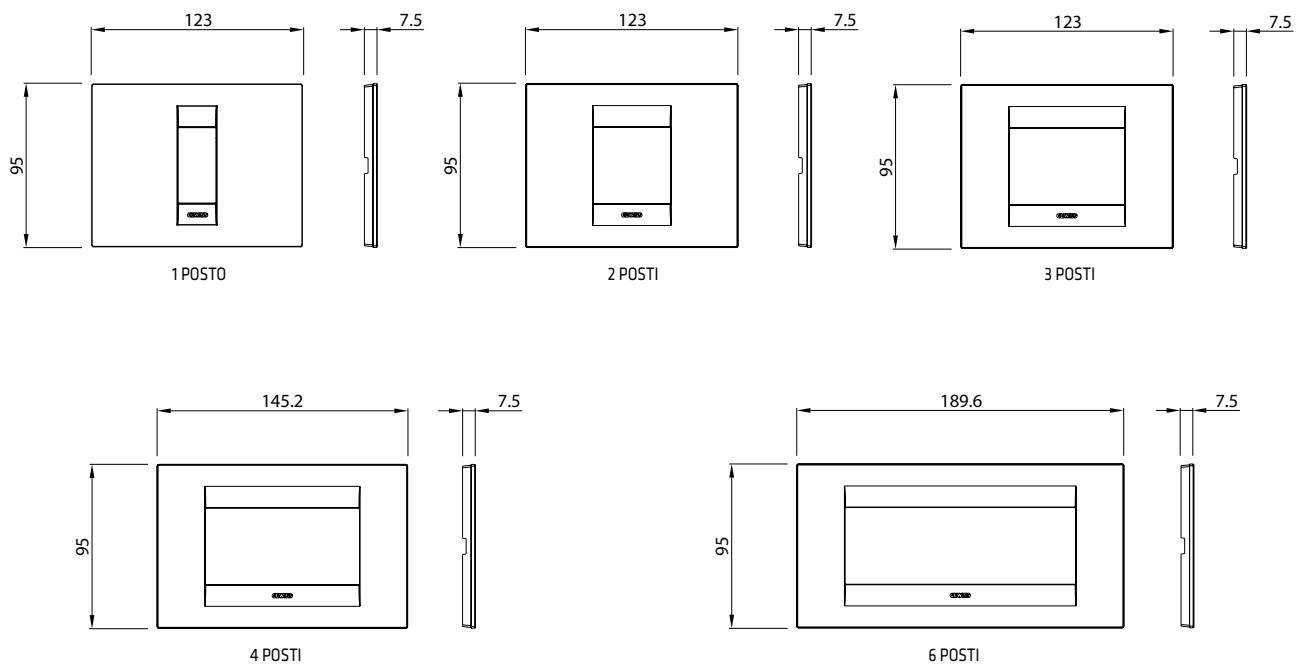

## PLACCHE GEO INTERNATIONAL

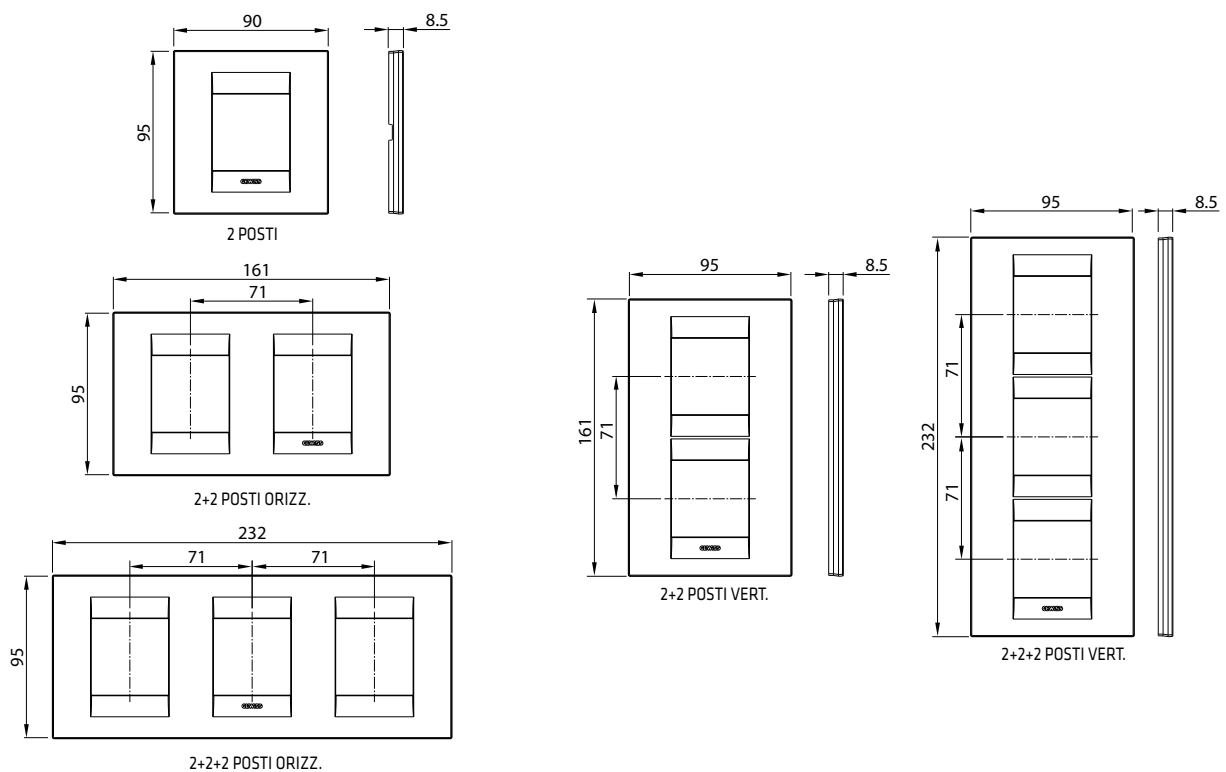

## PLACCHE LUX

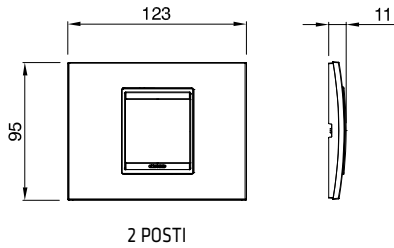

2 POSTI

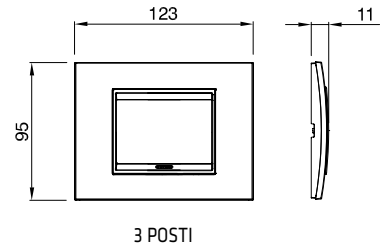

3 POSTI

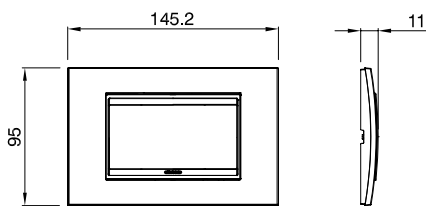

4 POSTI

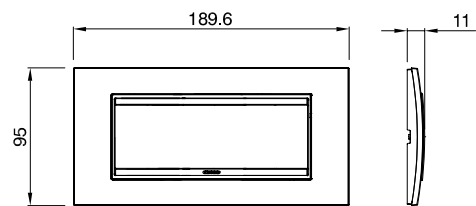

6 POSTI

## PLACCHE LUX INTERNATIONAL

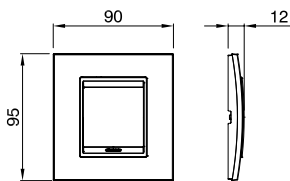

2 POSTI

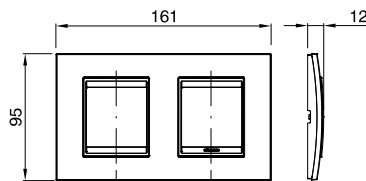

2+2 POSTI ORIZZ.

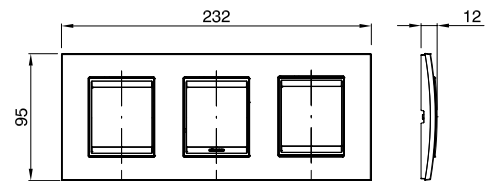

2+2+2 POSTI ORIZZ.

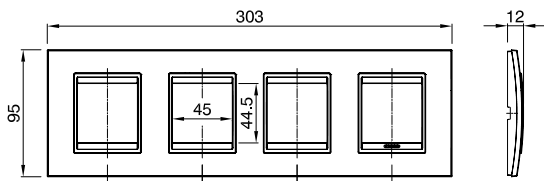

2+2+2+2 POSTI ORIZZ.

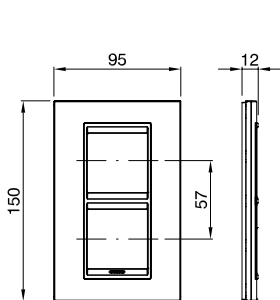

2+2 POSTI VERT. INTERASSE 57

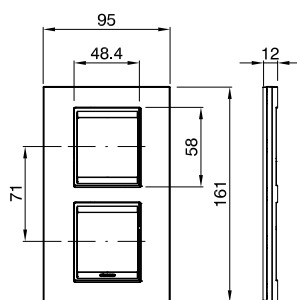

2+2 POSTI VERT. INTERASSE 71

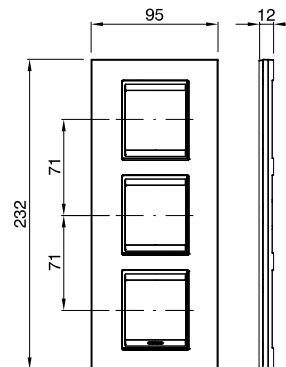

2+2+2 POSTI VERT.

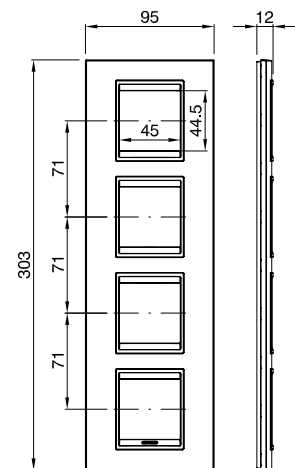

2+2+2+2 POSTI VERT.

## PLACCHE ART

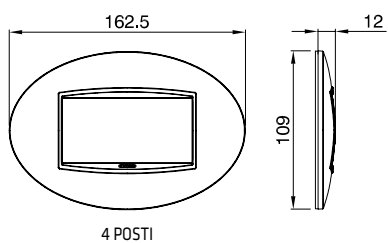
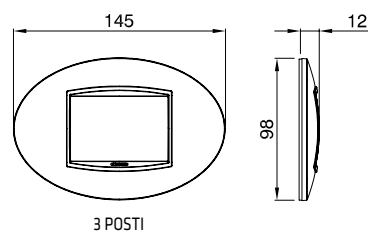
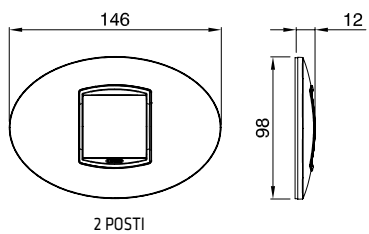



## PLACCHE ICE

### Placche ICE

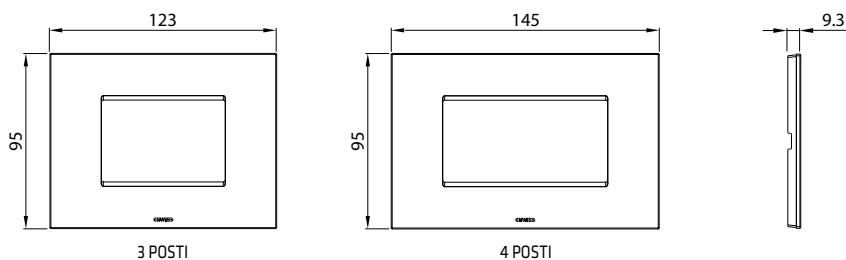

### Placche ICE touch con simboli serigrafati

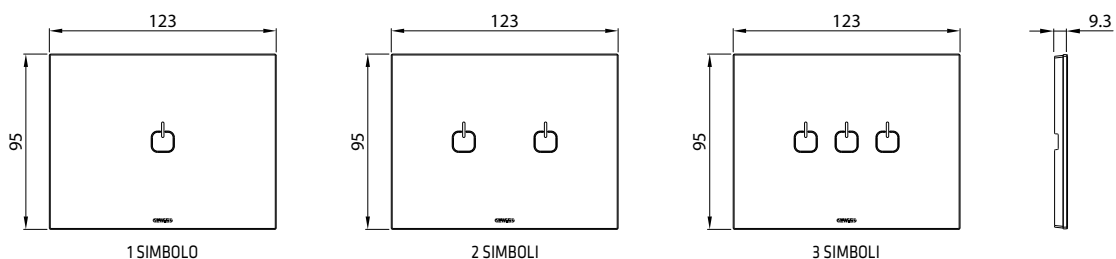

### Placche ICE touch KNX con simboli serigrafati

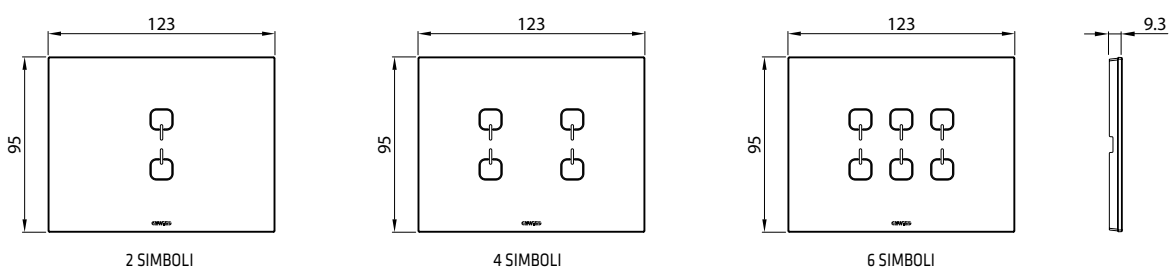

### Placche ICE touch KNX (per pulsantiere con simboli intercambiabili)

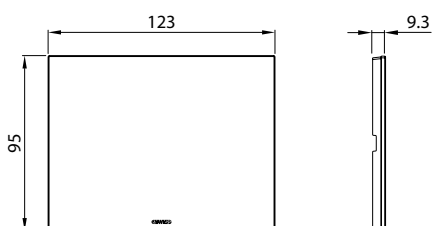

## PLACCHE STAGNE - IP55

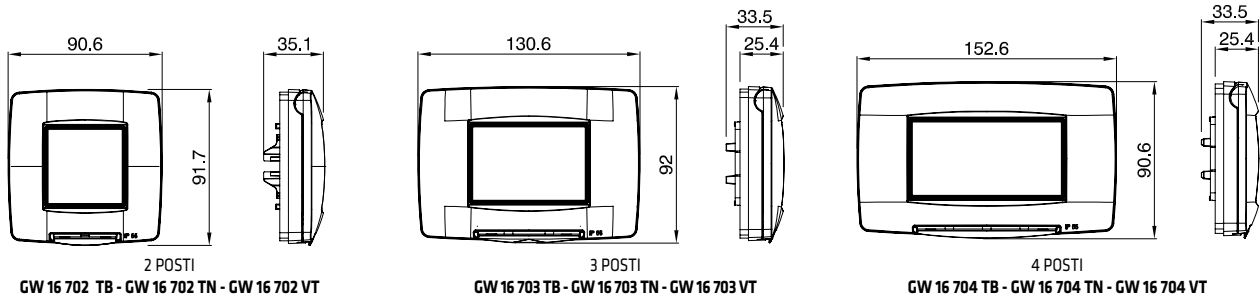

## PLANCE DA TAVOLO - ADATTE A PLACCHE ONE

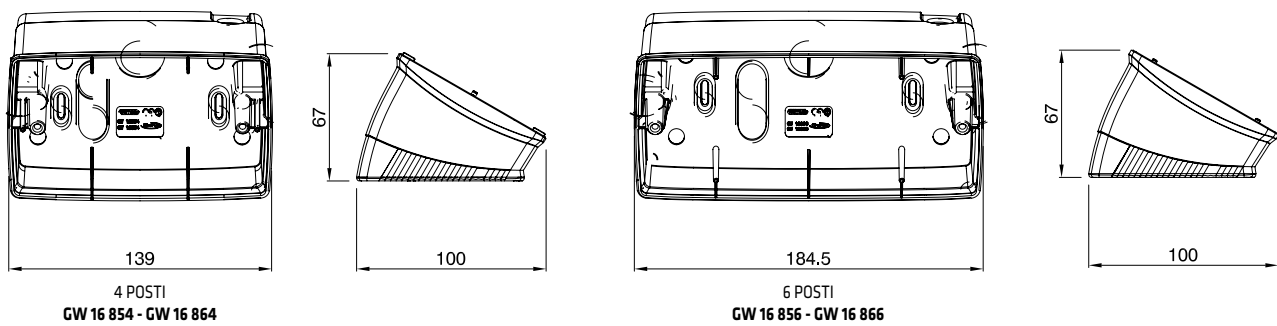

Coppia di serraggio viti: 0,8 Nm

## SCATOLE DA PARETE - ADATTE A PLACCHE ONE

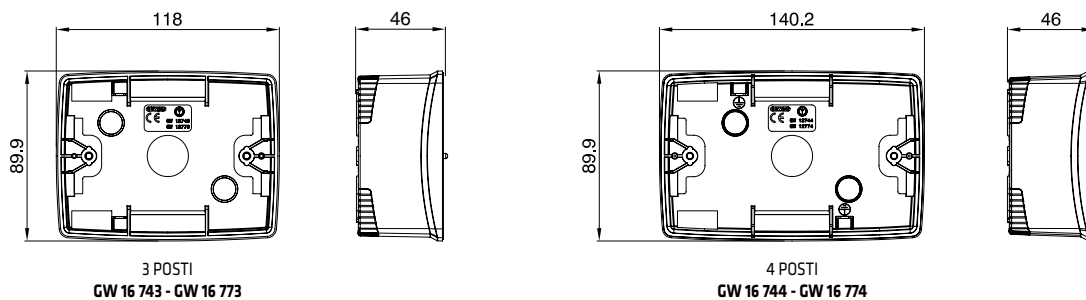

Coppia di serraggio viti: 0,8 Nm

## SCATOLE DA PARETE - ADATTE A PLACCHE ONE INTERNATIONAL

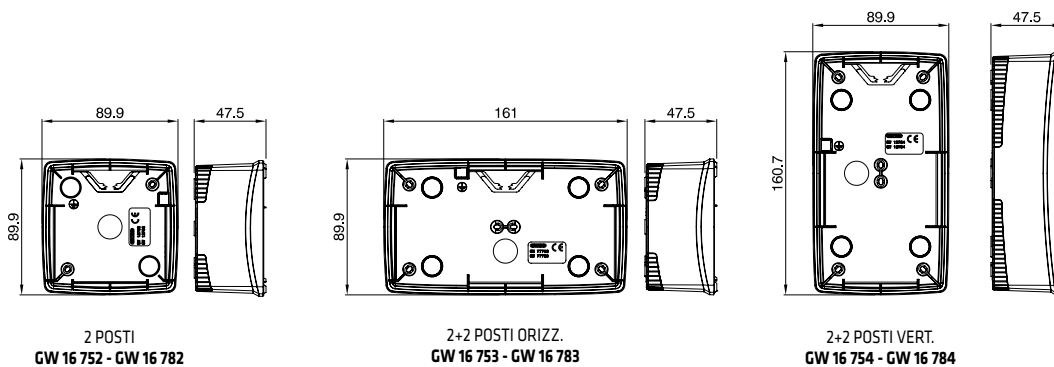

Coppia di serraggio viti: 0,8 Nm

## PLACCHE AUTOPORTANTI PER PROFILATI E PANNELLI

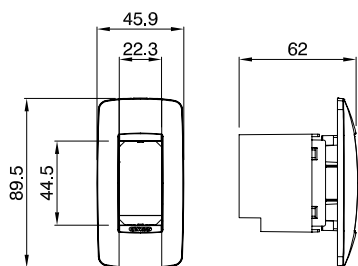

1 POSTO  
GW 16 711 TB - GW 16 711 TN - GW 16 711 VT

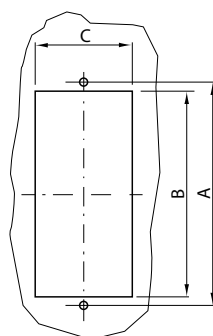

DIMENSIONI DELLO SCASSO

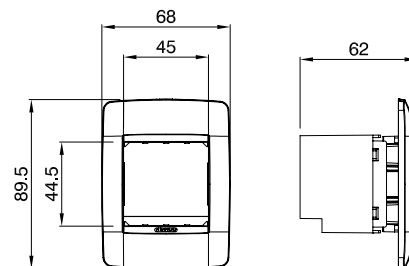

2 POSTI  
GW 16 712 TB - GW 16 712 TN - GW 16 712 VT

Codice	A	B	C
GW 16 711 TB	67	54	31,5
GW 16 711 TN			
GW 16 711 VT			
GW 16 712 TB	67	54	56,5
GW 16 712 TN			
GW 16 712 VT			

## PLACCHE CIECHE

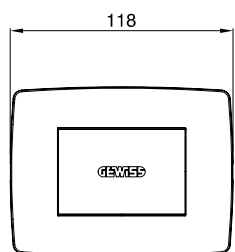

3 POSTI  
GW 16 723 TB - GW 16 723 TN

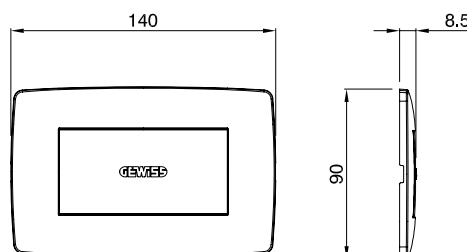

4 POSTI  
GW 16 724 TB - GW 16 724 TN

## SUPPORTI GUIDA DIN

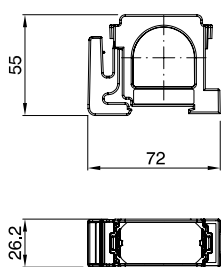

1 modulo  
GW 16 841

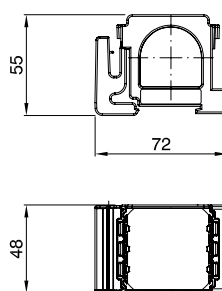

2 moduli  
GW 16 842

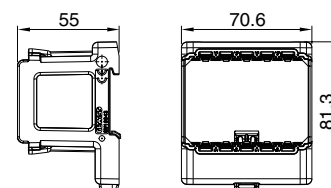

3 moduli  
GW 16 843

## CONTENITORI AUTOPORTANTI VUOTI PROTETTI IP40

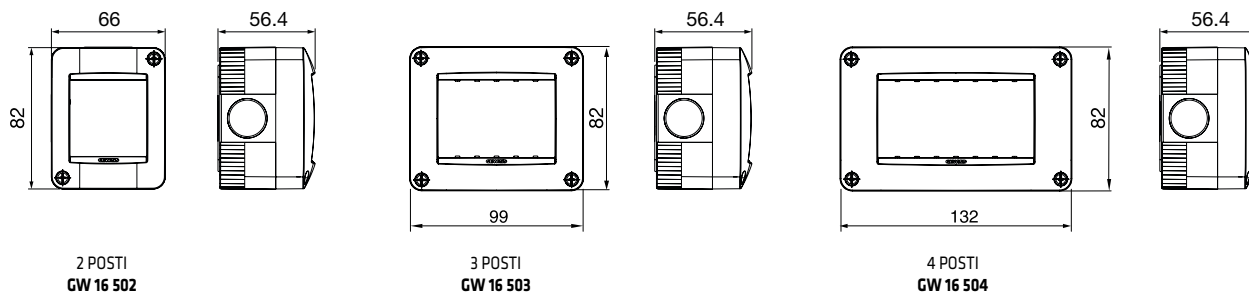

Coppia di serraggio viti: 0,8 Nm

## CONTENITORI AUTOPORTANTI VUOTI STAGNI IP55

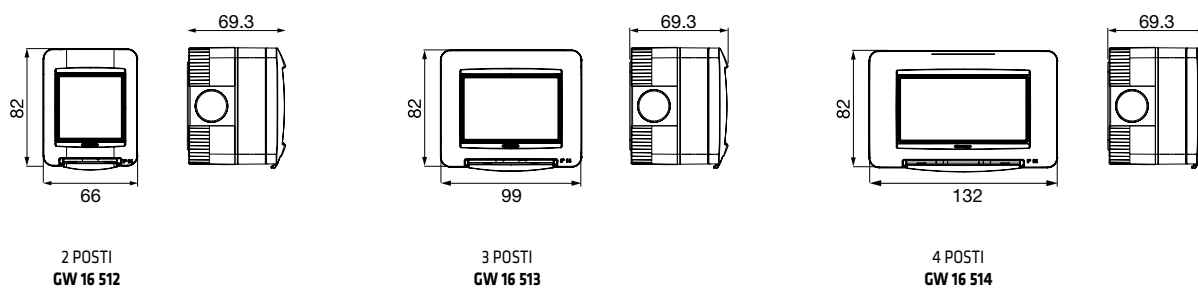

Coppia di serraggio viti: 0,8 Nm

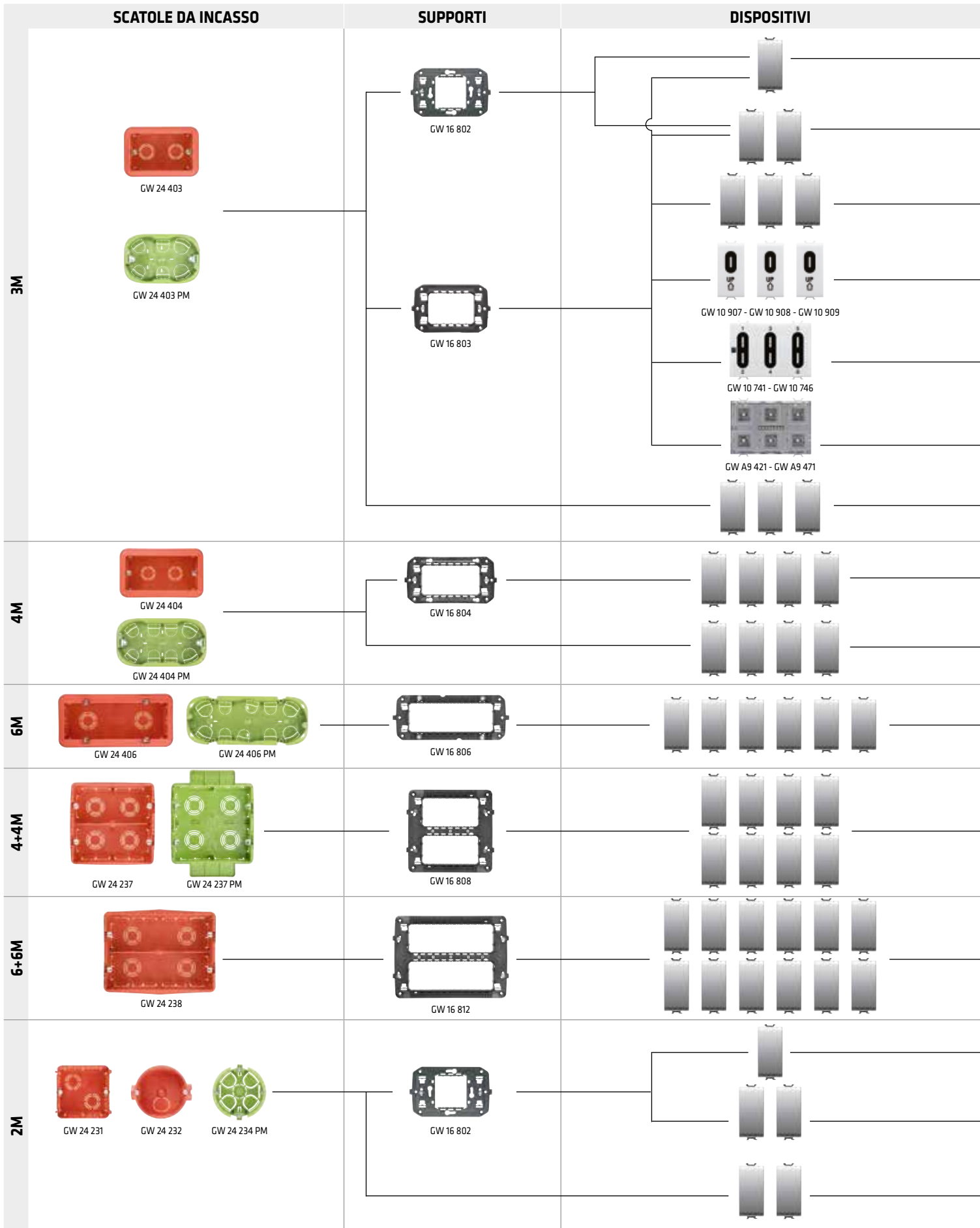

## PLACCHE

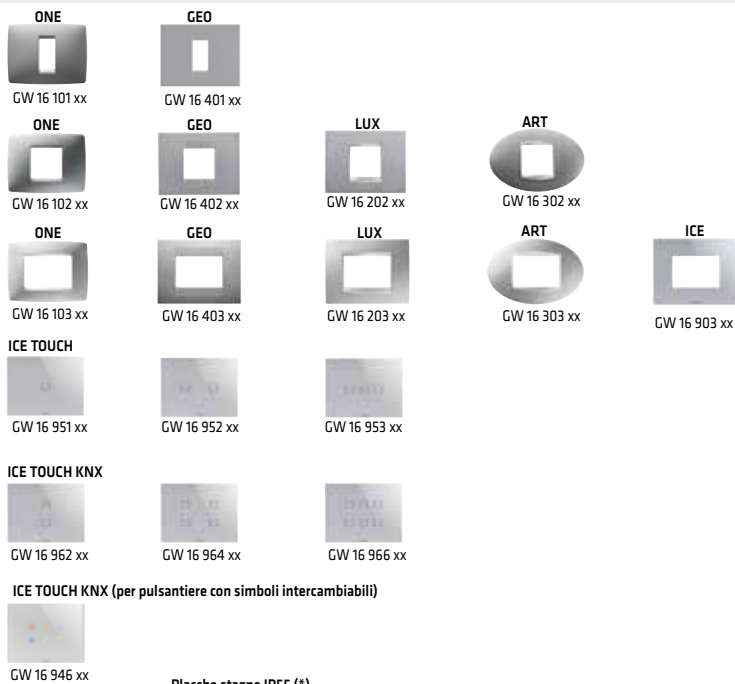

Placche stagne IP55 (\*)



GW 16 703 xx



Placche stagne IP55 (\*)



GW 16 704 xx

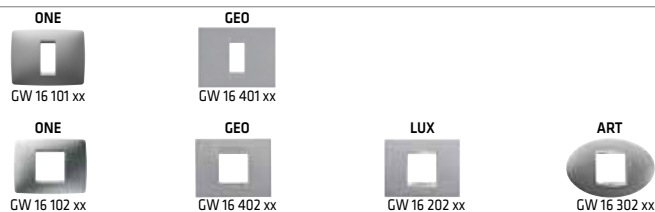
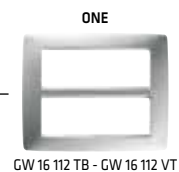
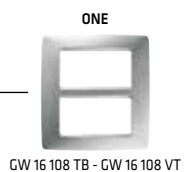

Placche stagne IP55 (\*)



GW 16 702 xx

(\*) Supporti già inclusi

Per informazioni tecniche contattate il SAT o visitate il sito [gewiss.com](http://gewiss.com)

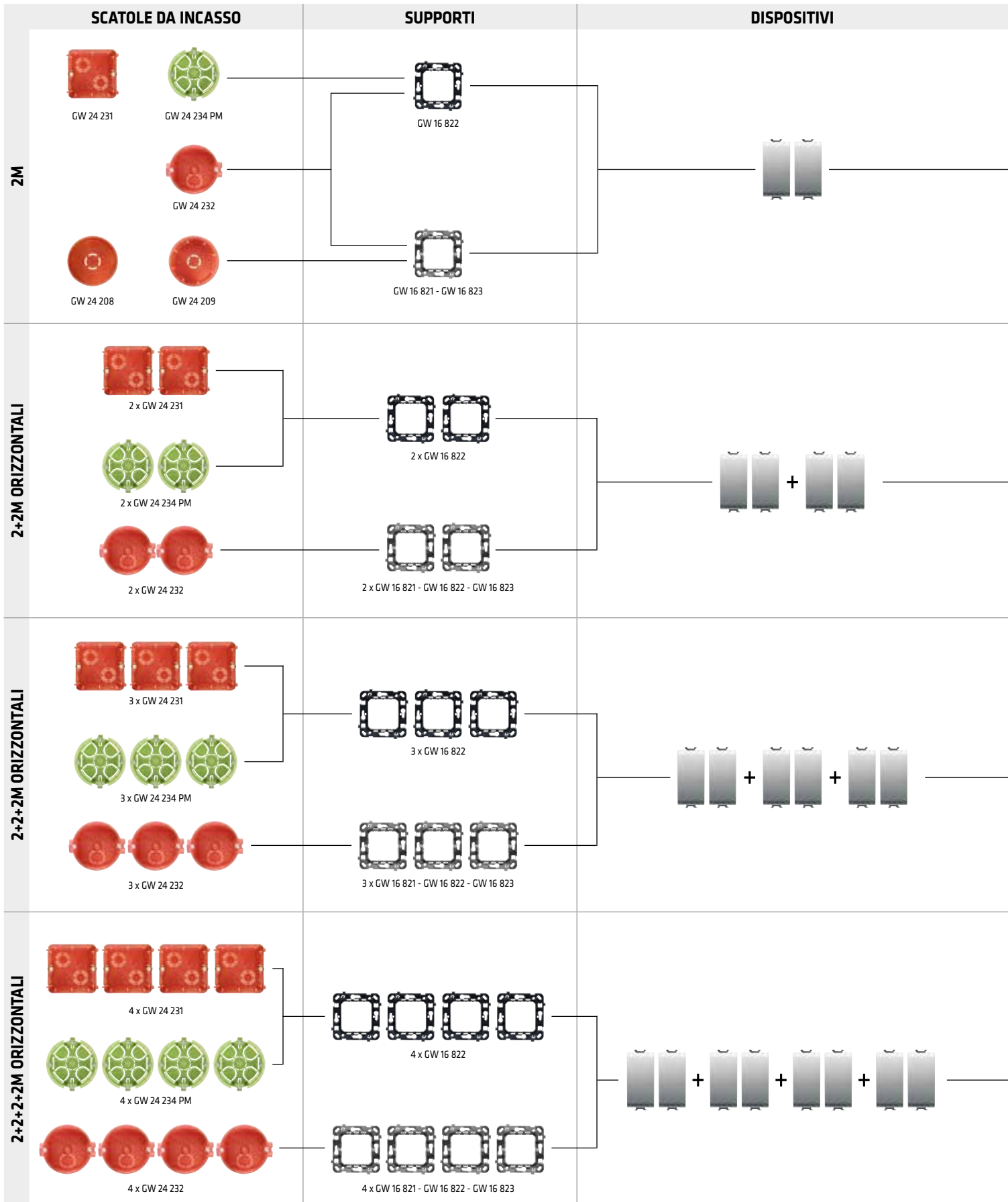



## PLACCHE

ONE  
INTERNATIONAL



GW 16 122 xx

GEO  
INTERNATIONAL



GW 16 422 xx

LUX  
INTERNATIONAL



GW 16 222 xx

ONE  
INTERNATIONAL



GW 16 123 xx

GEO  
INTERNATIONAL



GW 16 423 xx

LUX  
INTERNATIONAL



GW 16 223 xx

ONE  
INTERNATIONAL



GW 16 126 xx

GEO  
INTERNATIONAL



GW 16 426 xx

LUX  
INTERNATIONAL



GW 16 226 xx

ONE  
INTERNATIONAL



GW 16 128 xx

LUX  
INTERNATIONAL



GW 16 228 xx

	SCATOLE DA INCASSO	SUPPORTI	DISPOSITIVI
<b>2+2M VERTICALI 57MM</b>	<p>GW 24 282 PM</p>	<p>2 x GW 16 822 (*)</p> <p>(*) Accoppiare due supporti GW 16 822 in senso verticale rimuovendo da entrambi le rispettive alette pretranciate.</p>	
<b>2+2M VERTICALI</b>	<p>2 x GW 24 231</p> <p>2 x GW 24 234 PM</p> <p>2 x GW 24 232</p>	<p>2 x GW 16 822</p> <p>2 x GW 16 821 - GW 16 822 - GW 16 823</p>	
<b>2+2+2M VERTICALI</b>	<p>3 x GW 24 231</p> <p>3 x GW 24 234 PM</p> <p>3 x GW 24 232</p>	<p>3 x GW 16 822</p> <p>3 x GW 16 821 - GW 16 822 - GW 16 823</p>	
<b>2+2+2+2M VERTICALI</b>	<p>4 x GW 24 231</p> <p>4 x GW 24 234 PM</p> <p>4 x GW 24 232</p>	<p>4 x GW 16 822</p> <p>4 x GW 16 821 - GW 16 822 - GW 16 823</p>	

## PLACCHE

ONE  
INTERNATIONAL



GW 16 125 xx

LUX  
INTERNATIONAL



GW 16 225 xx

ONE  
INTERNATIONAL



GW 16 124 xx

GEO  
INTERNATIONAL



GW 16 424 xx

LUX  
INTERNATIONAL



GW 16 224 xx

ONE  
INTERNATIONAL



GW 16 127 xx

GEO  
INTERNATIONAL



GW 16 427 xx

LUX  
INTERNATIONAL



GW 16 227 xx

ONE  
INTERNATIONAL



















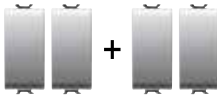

GW 16 129 xx

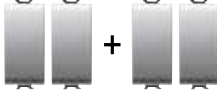
LUX  
INTERNATIONAL

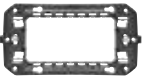

GW 16 229 xx

	SCATOLE DA PARETE E PLANCE DA TAVOLO	SUPPORTI	DISPOSITIVI
<b>3M</b>	 <p>GW 16 743 - GW 16 773</p>	 <p>GW 16 803</p>	
<b>4M</b>	 <p>GW 16 744 - GW 16 774</p>	 <p>GW 16 804</p>	
<b>2M</b>	 <p>GW 16 752 - GW 16 782</p>	 <p>GW 16 822</p>	
<b>2+2M ORIZZONTALI</b>	 <p>GW 16 753 - GW 16 783</p>	 <p>2 x GW 16 822</p>	
<b>2+2M VERTICALI</b>	 <p>GW 16 754 - GW 16 784</p>	 <p>2 x GW 16 822</p>	
<b>4M</b>	 <p>GW 16 854 - GW 16 864</p>	 <p>GW 16 804</p>	
<b>6M</b>	 <p>GW 16 856 - GW 16 866</p>	 <p>GW 16 806</p>	

## PLACCHE

ONE



GW 16 103 xx

ONE



GW 16 104 xx

ONE  
INTERNATIONAL



GW 16 122 xx

ONE  
INTERNATIONAL



GW 16 123 xx

ONE  
INTERNATIONAL



GW 16 124 xx

ONE



GW 16 104 xx

ONE



GW 16 106 xx